

Articulate Boomlift (Engine)

Articulate Boomlift (Engine)

●Z34/221C

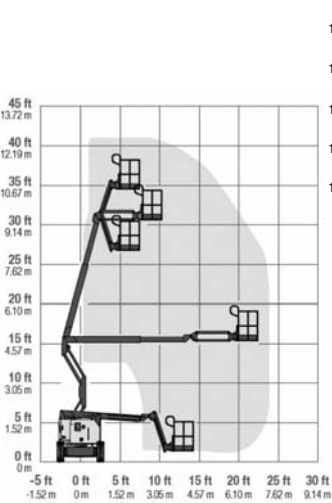

●Z45/25

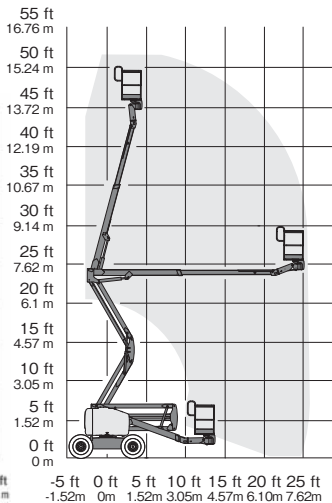

●Z60/34

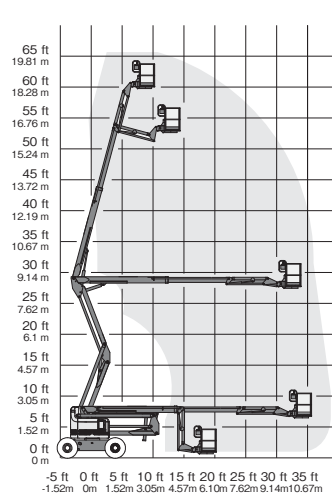

●Z62/40

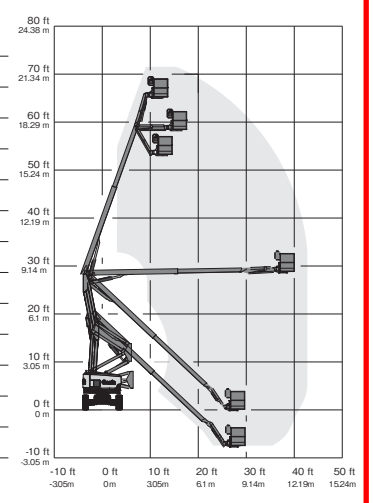

Z45/25

●HA260

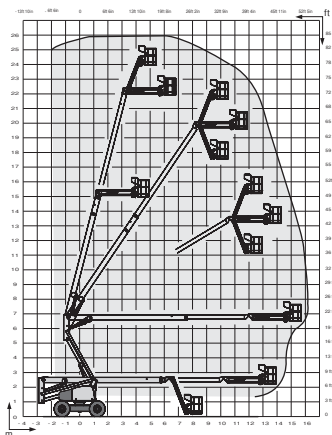

●Z80

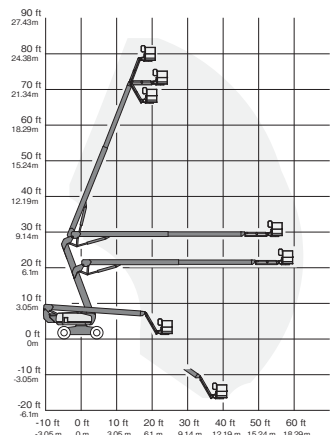

●Z135

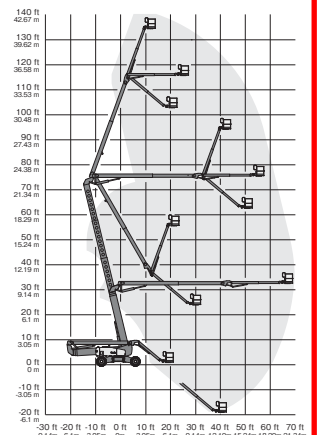

Specifications

Model	Z34/221C	Z45/25	Z60/34	Z62/40	HA260PX	Z80/60	Z135/70
Max. working height (m)	12.54	15.86	20.39	20.87	25.6	25.77	43.15
Max. platform height (m)	10.54	13.86	18.39	18.87	23.6	23.77	41.15
Max. Horizontal reach (m)	6.78	7.62	11.05	12.42	16.2	18.29	21.26
Safe working load (kg)	227	227	227	227	230	227	272
Platform length (m)	A 0.76	0.76	0.91	0.91	0.8	0.91	0.91
Platform width (m)	B 1.42	1.83	2.44	2.44	1.8	2.44	2.44
Height - stowed (m)	C 2.06	2.13	2.69	2.56	2.67	3.00	3.07
Length - stowed (m)	D 5.66	6.65	8.15	9.25	12	11.27	12.93
Width (m)	E 1.85	2.29	2.46	2.49	2.38	2.49	3.94
Wheelbase (m)	F 1.88	2.03	2.51	2.51	2.8	2.85	4.11
Ground clearance - center (m)	G 0.17	0.39	0.41	0.37	0.42	0.3	0.51
Weight (kg)	4,740	6,460	10,215	10,430	15,950	17,010	20,366
Power Source	Diesel Engine						

*Specifications will be changed by year of manufacture.

